

RoHS Compliance

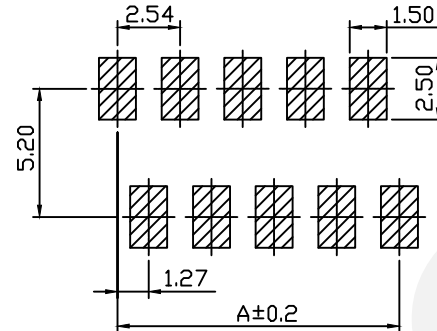
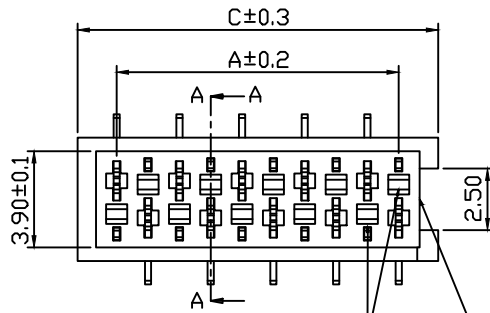

Material:
 Housing: PA46/PA9T UL94V-0
 Contacts: Phosphor Bronze
 Plating: Sn Over 50u" Nickel

Electrical Characteristics:
 Current Rating : 1.0AMP
 Voltage Rating: 230V AC/DC
 Withstand Voltage: 500V AC/Minute
 Contact Resistance: 20MΩ ohm Max
 Insulator Resistance: 1000MΩ ohm Min
 Operating Temperature:-40°C~+105°C

REFERENCE MATING INTERFACE PATTERN:
 1.27 STAGGERED PITCHx15 ROW-DISTANCE

POLARISATION SOLT Recommended P.C.B Layout

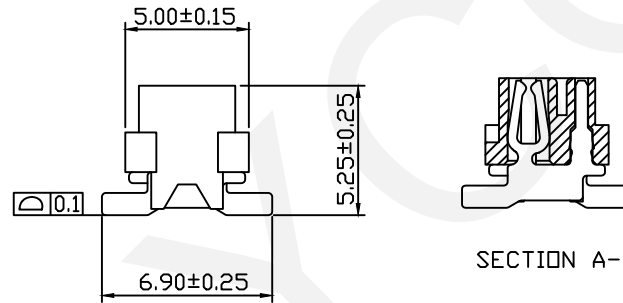
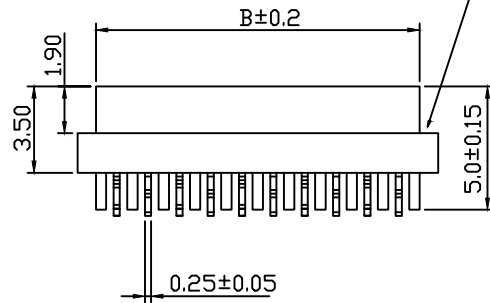

SECTION A-A

Order Information:

ERYAY04G-XX-R-□-□

Pitch:2.54mm

XX-No.of 04~26pin

Color:R-Red B-Black

Material:

NONE=PA9T E=PA46

Packing:

TC=Cap+Tube C-R=Cap+Reel

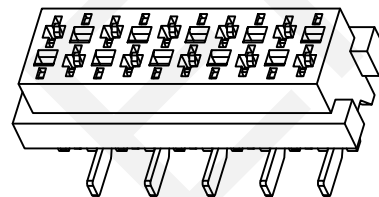
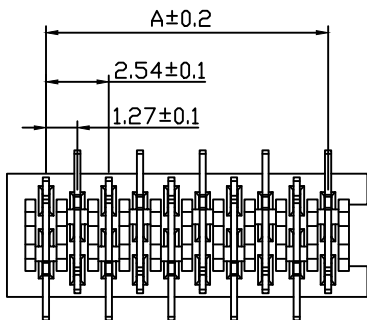

Poles	DIM.A	DIM.B	DIM.C	Qty/Tube
04	3.81	5.50	6.99	82
06	6.35	8.04	9.53	60
08	8.89	10.58	12.07	48
10	11.43	13.12	14.61	39
12	13.97	15.66	17.15	33
14	16.51	18.20	19.69	29
16	19.05	20.74	22.23	26
18	21.59	23.28	24.77	23
20	24.13	25.82	27.31	21
22	26.67	28.36	29.85	19
24	29.21	30.90	32.39	17
26	31.75	33.44	34.93	16

NINGBO ERYCO ELECTRONIC CO.,LTD

UNITS:mm	SHEET SIZE: A4	SCALE:---	DRWN BY PAN
0~3	3~18	18~50	50~120
±0.12	±0.15	±0.3	±0.5
			CHK'D BY FENG
			APPR BY ZHAN

Micro-Match Connector,Socket, Female, SMT

THIRD ANGLE PROJECTION

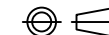

ERYAY04G-XX-R-□-□