

RoHS Compliance

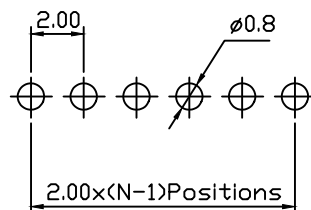

Recommended P.C.B Hole Layout

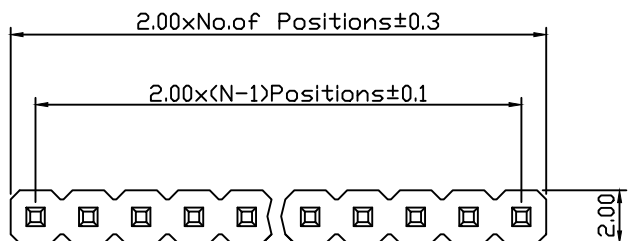
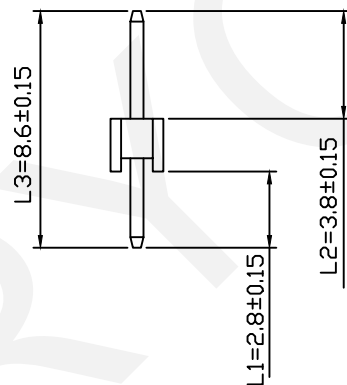
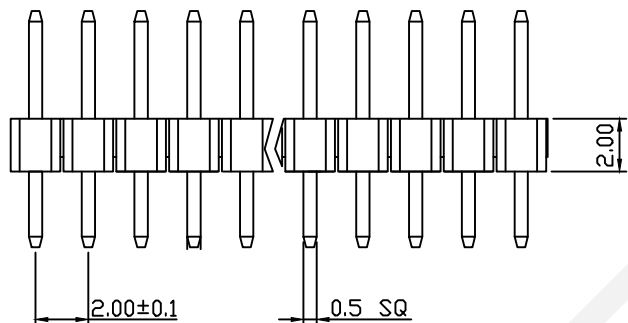

Dimension Antitheses List (mm)				
ITEM	L1	L2	L3	Plastic Height
Standard	2.80	3.80	8.60	2.00
Nonstandard	---	---	---	---

Material:
 Standard: PA6T
 Contact: Brass
 Insulator: Polyester,UL94V-0
 Electrical Characteristics:
 Rated Current: 1.5AMP
 Contact Resistance: 20mΩ Max
 Withstand Voltage: 500V AC/DC
 Insulator Resistance: 1000MΩ Min
 Mechanical
 Operating Temperature: -40°C~+105°C
 Max.Processing Temp:240°C For30-60
 Seconds(260°C For 10 Seconds)

Order Information:
 ERYAY07B-2.00-1-XX-S-L1xL2xL3-G0

Pin Header Series
 07B:2.00mm
 Plastics Height: 1.50,2.00mm
 Per Row:Single Layer
 Pin: No. Of Pins (1x40)
 Type: Straight Pin.
 Size:L1xL2xL3
 Plating:
 G0=Gold Flash G1=1u" Gold
 G10=10u" Gold G15=15u" Gold
 G30=30u" Gold

NINGBO ERYCO ELECTRONIC CO.,LTD

UNITS:mm	SHEET SIZE: A4				SCALE:---	DRWN BY PAN
0~3	3~18	18~50	50~120	CHK'D BY FENG	THIRD ANGLE PROJECTION	
±0.12	±0.15	±0.3	±0.5	APPR BY ZHAN		

2.00mm Pin Header
 Single Layer, Straight Pin, 1xN Pin
 ERYAY07B-2.00-1-XX-S-L1xL2xL3-G0

RoHS Compliance

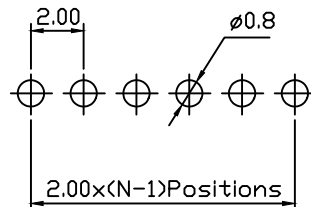
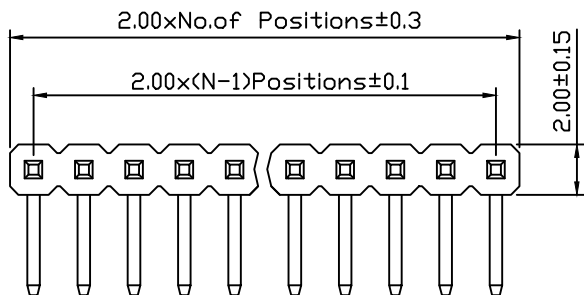

Recommended P.C.B Hole Layout

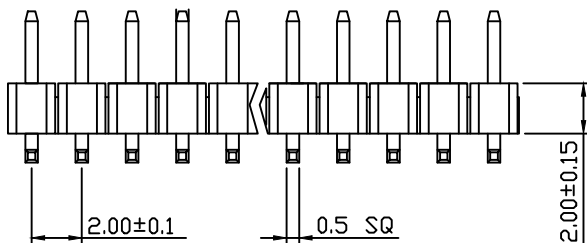

Dimension Antitheses List (mm)				
ITEM	L1	L2	L3	Plastic Height
Standard R1	2.80	3.80	1.00	2.00
Standard R2	2.80	3.80	1.00	2.00
Nonstandard	---	---	---	---

Material:
 Standard: PBT
 Contact: Phosphor Bronze
 Insulator: Polyester,UL94V-0
 Electrical Characteristics:
 Rated Current: 15AMP
 Contact Resistance: 20mΩ Max
 Withstand Voltage: 500V AC/DC
 Insulator Resistance: 1000MΩ Min
 Mechanical
 Operating Temperature: -40°C~+105°C

Order Information:

ERYAY07B-2.00-1-XX-R1-L1xL2xL3-G0

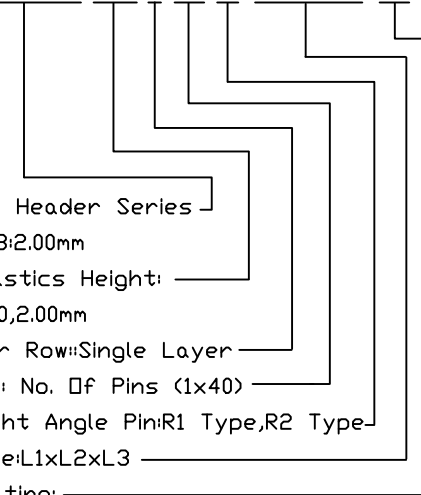

Pin Header Series
 07B:2.00mm
 Plastics Height:
 1.50,2.00mm
 Per Row:Single Layer
 Pin: No. of Pins (1x40)
 Right Angle Pin:R1 Type,R2 Type
 Size:L1xL2xL3
 Plating:
 G0=Gold Flash G1=1u" Gold
 G10=10u" Gold G15=15u" Gold
 G30=30u" Gold

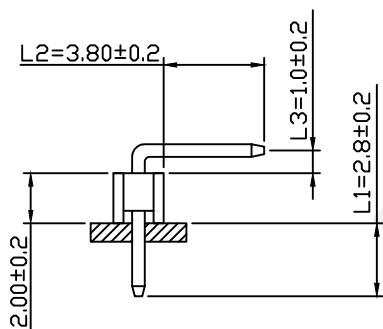

R1 Type

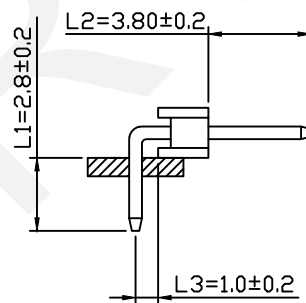

R2 Type

NINGBO ERYCO ELECTRONIC CO.,LTD

UNITS:mm	SHEET SIZE: A4	SCALE:---	DRWN BY PAN
0~3	3~18	18~50	50~120
±0.12	±0.15	±0.3	±0.5
			CHK'D BY FENG
			APPR BY ZHAN

2.00mm Pin Header Single Layer,Right Angle Pin, 1xN Pin	
THIRD ANGLE PROJECTION	ERYAY07B-2.00-1-XX-R1-L1xL2xL3-G0

RoHS Compliance

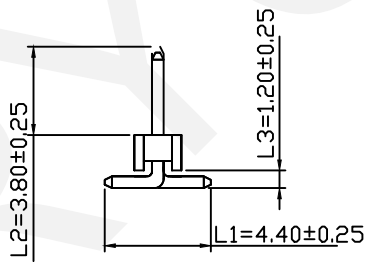
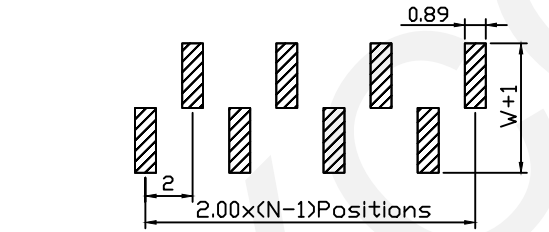
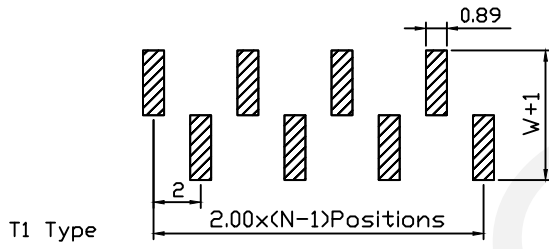
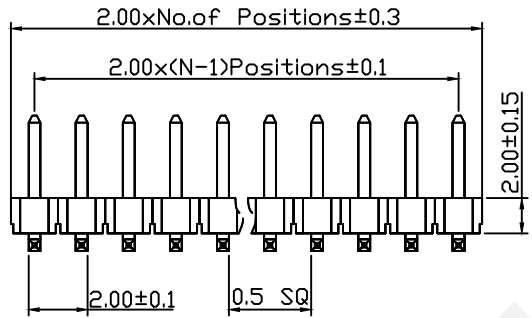
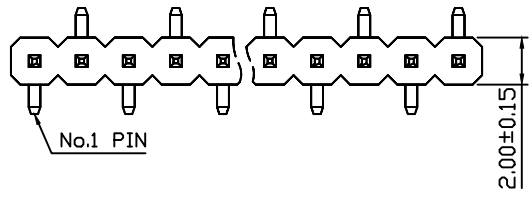
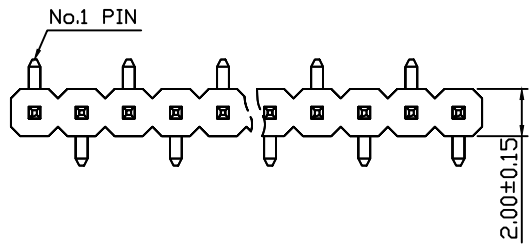

Dimension Antitheses List (mm)				
ITEM	L1	L2	L3	Plastic Height
Standard	4.00	3.80	1.20	2.00
Nonstandard	---	---	---	---

Material:
 Standard: PA6T
 Contact: Brass
 Insulator: Polyester,UL94V-0
 Electrical Characteristics:
 Rated Current: 1.5AMP
 Contact Resistance: 20mΩ Max
 Withstand Voltage: 500V AC/DC
 Insulator Resistance: 1000MΩ Min
 Mechanical
 Operating Temperature: -40°C~+105°C
 Max.Processing Temp:230°C For30-60 Seconds(260°C For10 Seconds)

Order Information:
 ERYAY07B-2.00-1-XX-T1-L1xL2xL3-G0-N-R

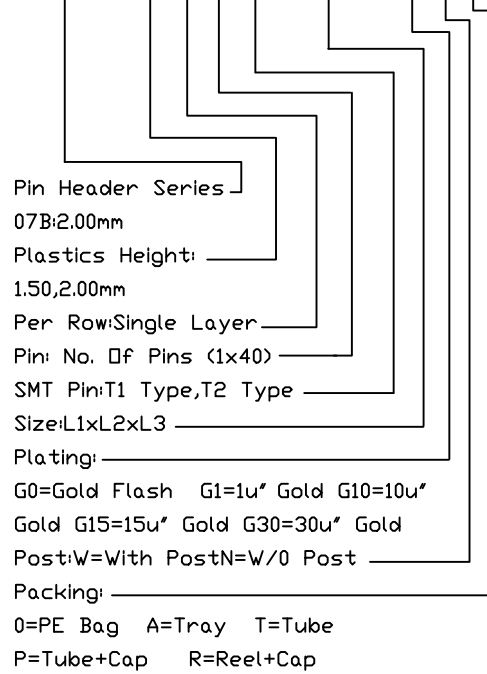

NINGBO ERYCO ELECTRONIC CO.,LTD

UNITS:mm	SHEET SIZE: A4		SCALE:---	DRWN BY PAN
0~3	3~18	18~50	50~120	CHK'D BY FENG
±0.12	±0.15	±0.3	±0.5	APPR BY ZHAN

2.00mm Pin Header Single Layer,SMT,1xN Pin
 THIRD ANGLE PROJECTION
 ERYAY07B-2.00-1-XX-T1-L1xL2xL3-G0-N-R

RoHS Compliance

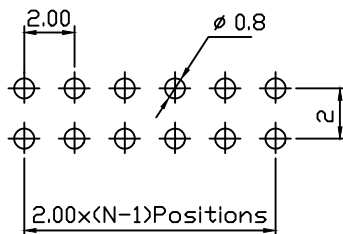
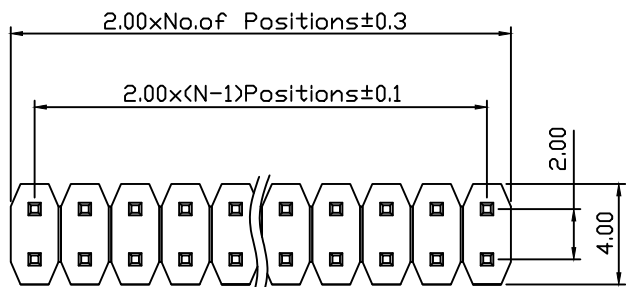

Recommended P.C.B Hole Layout

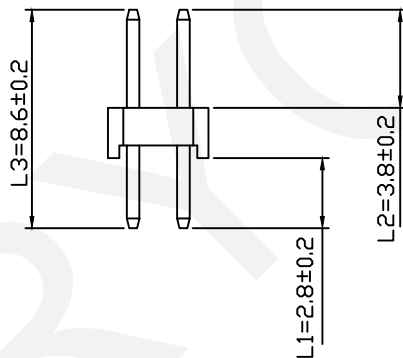
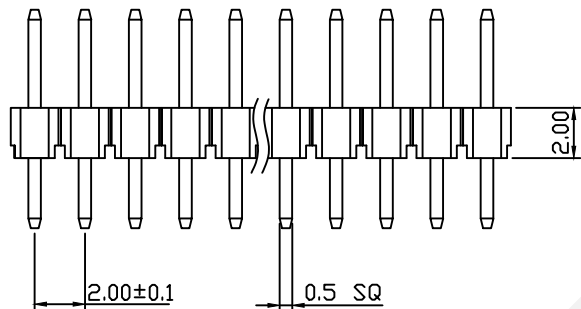

Dimension Antitheses List (mm)				
ITEM	L1	L2	L3	Plastic Height
Standard	2.80	3.80	8.60	2.00
Nonstandard	---	---	---	---

Material:
 Standard: PA6T
 Contact: Brass
 Insulator: Polyester,UL94V-0
 Electrical Characteristics:
 Rated Current: 1.5AMP
 Contact Resistance: 20mΩ Max
 Withstand Voltage: 500V AC/DC
 Insulator Resistance: 1000MΩ Min
 Mechanical
 Operating Temperature: -40°C~+105°C
 Max.Processing Temp:240°C For30-60 Seconds(260°C For10 Seconds)

Order Information:
 ERYAY07B-2.00-2-XX-S-L1xL2xL3-G0

Pin Header Series
 07B:2.00mm
 Plastics Height: 1.50,2.00
 Per Row:Double Layer
 Pin: No. Of Pins (02~80)
 Type: Straight Pin.
 Size:L1xL2xL3
 Plating:
 G0=Gold Flash G1=1u" Gold
 G10=10u" Gold G15=15u" Gold
 G30=30u" Gold

NINGBO ERYCO ELECTRONIC CO.,LTD

UNITS:mm	SHEET SIZE: A4			SCALE:---	DRWN BY PAN
0~3	3~18	18~50	50~120	CHK'D BY FENG	
±0.12	±0.15	±0.3	±0.5	APPR BY ZHAN	

2.00mm Pin Header
 Double Layer, Straight Pin, 2xN Pin
 THIRD ANGLE PROJECTION
 ERYAY07B-2.00-2-XX-S-L1xL2xL3-G0

RoHS Compliance

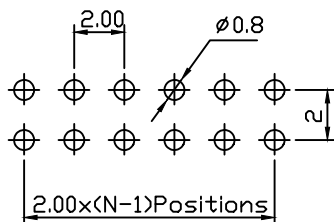
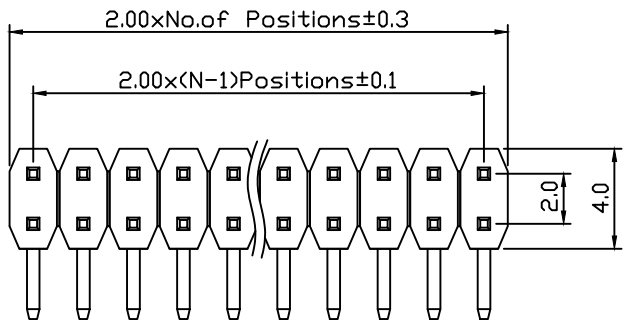

Recommended P.C.B Hole Layout

Material:
 Standard: PBT
 Contact: Phosphor Bronze
 Insulator: Polyester,UL94V-0
 Electrical Characteristics:
 Rated Current: 1.5AMP
 Contact Resistance: 20mΩ Max
 Withstand Voltage: 500V AC/DC
 Insulator Resistance: 1000MΩ Min
 Mechanical
 Operating Temperature: -40°C~+105°C

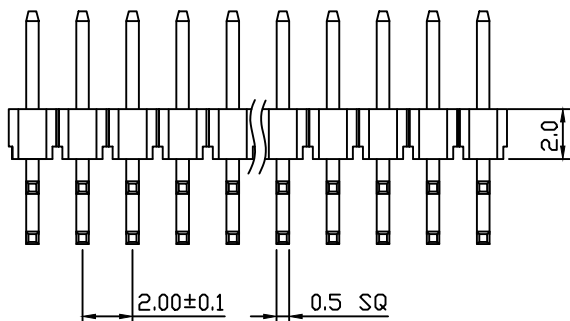

Dimension Antitheses List (mm)				
ITEM	L1	L2	L3	Plastic Height
Standard	2.80	3.80	1.00	2.00
Nonstandard	---	---	---	---

Order Information:
 ERYAY07B-2.00-2-XX-R1-L1xL2xL3-G0

Pin Header Series
 07B:2.00mm
 Plastics Height:
 1.50,2.00mm
 Per Row: Double Layer
 Pin: No. Of Pins (2~80)
 Right Angle Pin: R1 Type, R2 Type
 Size: L1xL2xL3
 Plating:
 G0=Gold Flash G1=1u" Gold
 G10=10u" Gold G15=15u" Gold
 G30=30u" Gold

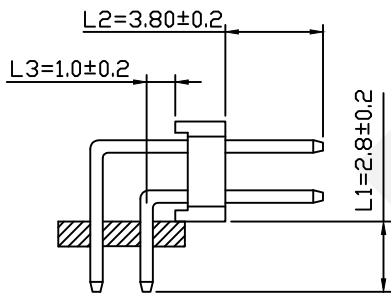

R1 Type

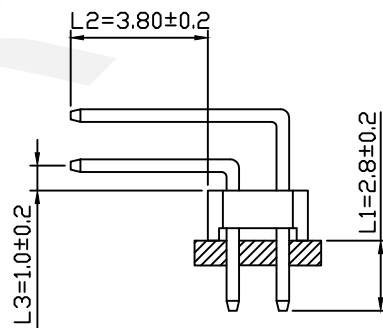

NINGBO ERYCO ELECTRONIC CO.,LTD

UNITS:mm	SHEET SIZE: A4	SCALE:---	DRWN BY PAN
0~3	3~18	18~50	50~120
±0.12	±0.15	±0.3	±0.5
			CHK'D BY FENG
			APPR BY ZHAN

2.00mm Pin Header
 Double Layer,Right Angle Pin, 2xN Pin
 THIRD ANGLE PROJECTION
 ERYAY07B-2.00-2-XX-R1-L1xL2xL3-G0

RoHS Compliance

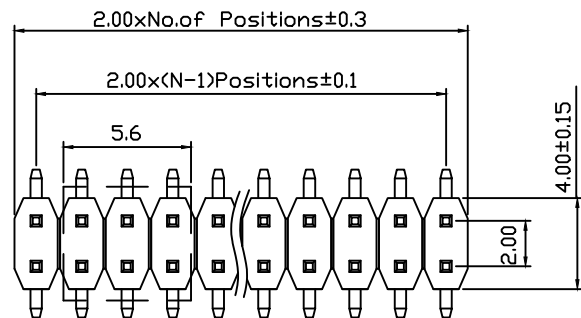

Recommended P.C.B Hole Layout

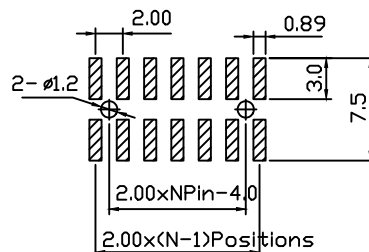

Material:
 Standard: PA6T
 Contact: Brass
 Insulator: Polyester,UL94V-0
 Electrical Characteristics:
 Rated Current: 1.5AMP
 Contact Resistance: 20mΩ Max
 Withstand Voltage: 500V AC/DC
 Insulator Resistance: 1000MΩ Min
 Mechanical
 Operating Temperature: -40°C~+105°C
 Max.Processing Temp:240°C For30-60
 Seconds(260°C For10 Seconds)

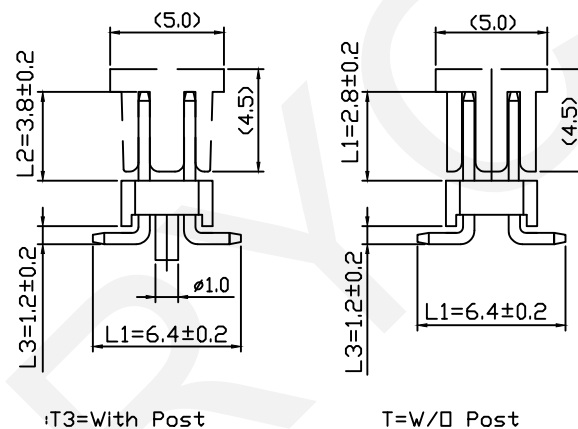
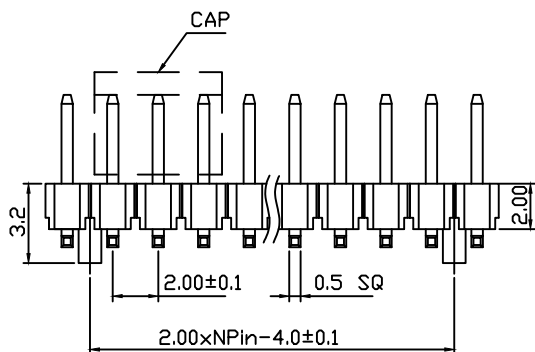

Dimension Antitheses List (mm)				
ITEM	L1	L2	L3	Plastic Height
Standard	6.40	3.80	1.20	2.00
Nonstandard	---	---	---	---

Order Information:

ERYAY07B-2.00-2-XX-T-L1xL2xL3-G0-R

Pin Header Series
 07B:2.00mm
 Plastics Height: _____
 1.50,2.00mm
 Per Row: Dual Row _____
 Pin: No. Of Pins (2~80) _____
 Post: T3=With Post T=W/D Post, _____
 Size: L1xL2xL3 _____
 Plating: _____
 G0=Gold Flash G1=1u' Gold G10=10u'
 Gold G15=15u' Gold G30=30u' Gold
 Packing: _____
 0=PE Bag A=Tray T=Tube
 P=Tube+Cap R=Reel+Cap

NINGBO ERYCO ELECTRONIC CO.,LTD

UNITS:mm SHEET SIZE: A4 SCALE:--- DRWN BY PAN
 0~3 3~18 18~50 50~120 CHK'D BY FENG
 ±0.12 ±0.15 ±0.3 ±0.5 APPR BY ZHAN

2.00mm Pin Header Dual Row,SMT,2xN Pin

THIRD ANGLE PROJECTION

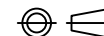

ERYAY07B-2.00-2-XX-T-L1xL2xL3-G0-R