

SECTION B-B

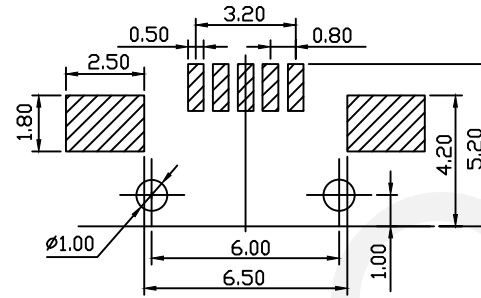

RECOMMENDED PCB LAYOUT

Material
 Housing:LCP UL94V-0 ,Black.
 Contact:Copper Alloy
 Shell:Copper Alloy

Finish:
 Contact:Gold Plating On Contact Area.
 80u" SN Plating On Solder Tail Area,
 50u" Min,Nickel Underplating Overall.

Electrical:
 Voltage Rating:30VAC RMS
 Current Rating:2.0A(pin 15);1.0A(pin 2 3 4).
 Contact Resistance: 50MΩ Max
 Insulation Resistance: 100MΩ Min.
 Dielectric Withstanding Voltage:
 500 V AC For 1 Minute.
 Operating Life:5000 Cycles.
 Operating Temperature:-20°C to+85°C

Order Information

ERYAY29-5FJ-B-R

Model
 Serial Number
 Color:B-Black
 R-Reel Packing

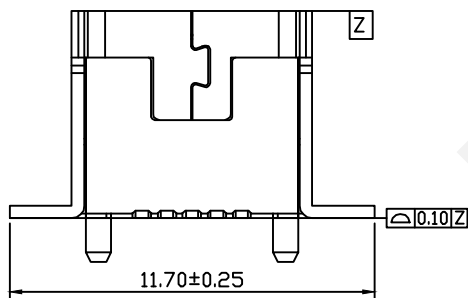
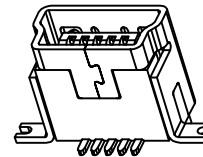
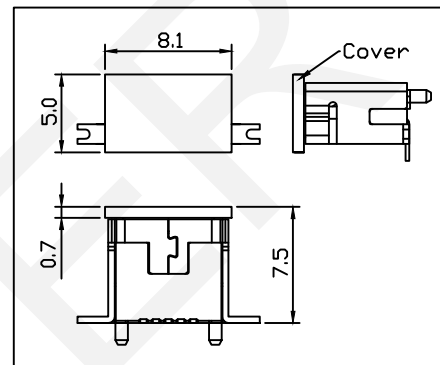
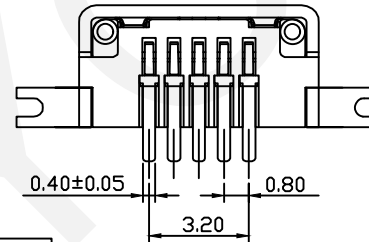
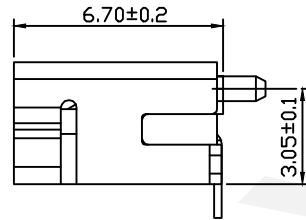
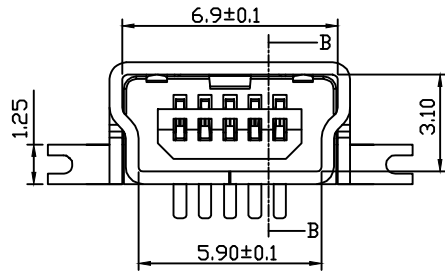

NINGBO ERYCO ELECTRONIC CO.,LTD

UNITS:mm	SHEET SIZE: A4			SCALE:---	DRWN BY PAN
0~3	3~18	18~50	50~120	CHK'D BY FENG	
±0.12	±0.15	±0.3	±0.5	APPR BY ZHAN	

Mini USB Connector 5Pin, B/F Vertical SMT	
THIRD ANGLE PROJECTION	ERYAY29-5FJ-B-R