

RoHS Compliant

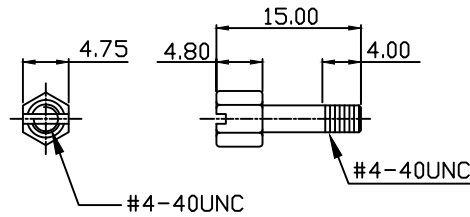
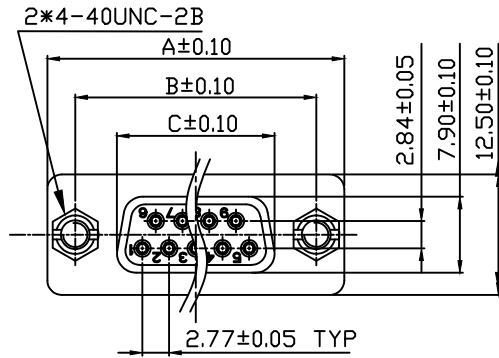

Screw Specification

Electrical Specification:

Current Rating: 2 AMP

Insulator Resistance: 5000M ohms Min. at DC 500V

Contact Resistance: 20m ohms Max. at DC 100mA

Operating Temperature: -55°C~+105°C

Material:

Housing: 30% Glass Filled PBT UL94V-0

Contacts: Phosphor Bronze

Shell: Steel, 100u" Tin Over 50u" Min Nickel

Clinch Nut: Brass, 100u" Min Nickel Plated

Screwlock: Brass, 100u" Min Nickel Plated

ORDER INFORMATION

Product NO.: ERYAYA85-XXF/XXF-L

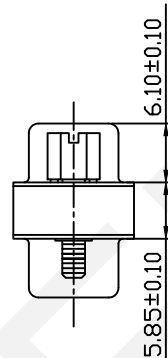
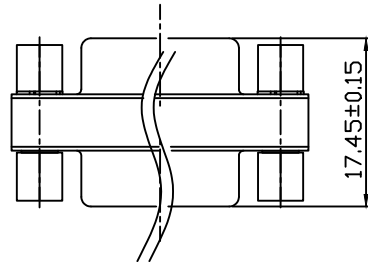

PIN NO.	DIM A	DIM B	DIM C
9P	30.80	24.99	16.35
15P	39.20	33.30	24.70
25P	53.05	47.04	38.40
37P	69.32	63.50	54.80

Contact Number of Row

A85=2 Row Type

Number of Contacts

9M/9M 15M/15M 25M/25M

9F/9F 15F/15F 25F/25F

9M/9F 15M/15F 25M/25F

L=Blue B=Black

NINGBO ERYCO ELECTRONIC CO.,LTD

UNITS:mm	SHEET SIZE: A4	SCALE:---	DRWN BY PAN
0~3	3~18	18~50	50~120
±0.12	±0.15	±0.3	±0.5

CHK'D BY FENG

APPR BY ZHAN

MINI ADAPTOR DB 9-25Pin Female-Female

THIRD ANGLE PROJECTION



ERYAYA85-XXF/XXF-L

RoHS Compliant

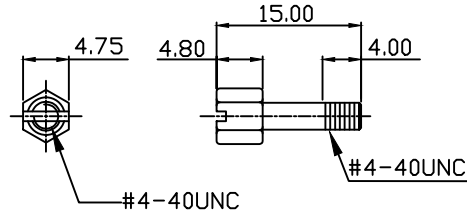
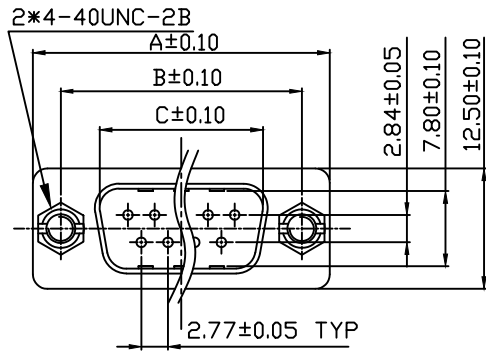

Screw Specification

Electrical Specification:

Current Rating: 2 AMP

Insulator Resistance: 5000M ohms Min. at DC 500V

Contact Resistance: 20m ohms Max. at DC 100mA

Operating Temperature: -55°C~+105°C

Material:

Housing: 30% Glass Filled PBT UL94V-0

Contacts: Phosphor Bronze

Shell: Steel, 100u" Tin Over 50u" Min Nickel

Clinch Nut: Brass, 100u" Min Nickel Plated

Screwlock: Brass, 100u" Min Nickel Plated

ORDER INFORMATION

Product NO.: ERYAYA85-XXM/XXM-L

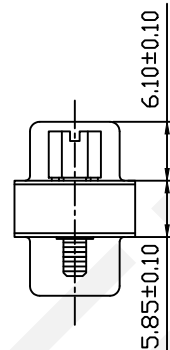
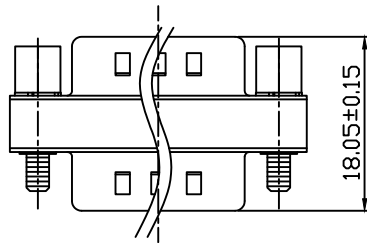

PIN NO.	DIM A	DIM B	DIM C
9P	30.80	24.99	16.92
15P	39.20	33.30	25.25
25P	53.05	47.04	38.96
37P	69.32	63.50	54.84

Contact Number of Row

A85=2 Row Type

Number of Contacts

9M/9M 15M/15M 25M/25M

9F/9F 15F/15F 25F/25F

9M/9F 15M/15F 25M/25F

L=Blue B=Black

NINGBO ERYCO ELECTRONIC CO.,LTD

UNITS:mm	SHEET SIZE: A4	SCALE:---	DRWN BY PAN
0~3	3~18	18~50	50~120
±0.12	±0.15	±0.3	±0.5

CHK'D BY FENG

APPR BY ZHAN

MINI ADAPTOR DB 9-25Pin Male-Male

THIRD ANGLE PROJECTION



ERYAYA85-XXM/XXM-L

RoHS Compliant

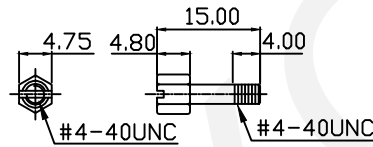
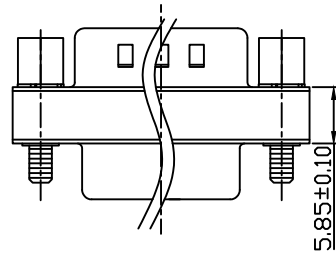
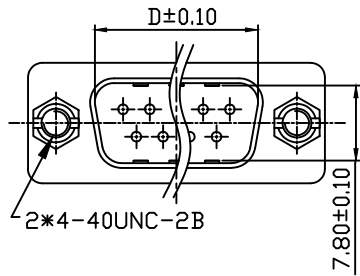

Screw Specification

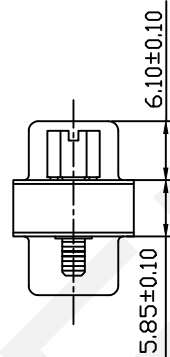
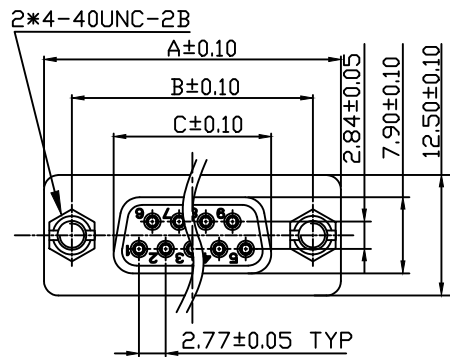

PIN NO.	DIM A	DIM B	DIM C
9P	30.80	24.99	16.35
15P	39.20	33.30	24.70
25P	53.05	47.04	38.40
37P	69.32	63.50	54.80

Electrical Specification:

Current Rating: 2 AMP

Insulator Resistance: 5000M ohms Min. at DC 500V

Contact Resistance: 20m ohms Max. at DC 100mA

Operating Temperature: -55°C~+105°C

Material:

Housing: 30% Glass Filled PBT UL94V-0

Contacts: Phosphor Bronze

Shell: Steel, 100u" Tin Over 50u" Min Nickel

Clinch Nut: Brass, 100u" Min Nickel Plated

Screwlock: Brass, 100u" Min Nickel Plated

ORDER INFORMATION

Product NO: ERYAYA85-XXM/XXF-L

Contact Number of Row

A85=2 Row Type

Number of Contacts

9M/9M 15M/15M 25M/25M

9F/9F 15F/15F 25F/25F

9M/9F 15M/15F 25M/25F

L=Blue B=Black

NINGBO ERYCO ELECTRONIC CO.,LTD

UNITS:mm

SHEET SIZE: A4

SCALE:---

DRWN BY PAN

MINI ADAPTOR DB 9-25Pin Male-Female

0~3

3~18

18~50

50~120

CHK'D BY FENG

THIRD ANGLE PROJECTION

±0.12

±0.15

±0.3

±0.5

APPR BY ZHAN

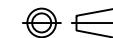

ERYAYA85-XXM/XXF-L

RoHS Compliant

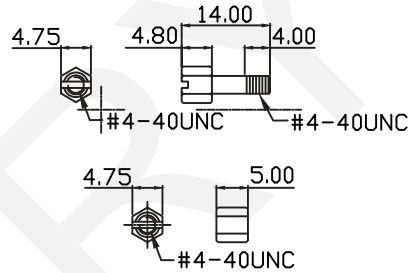
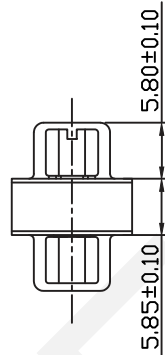
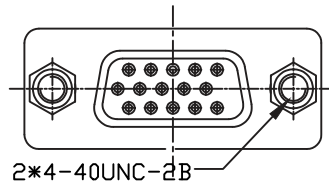
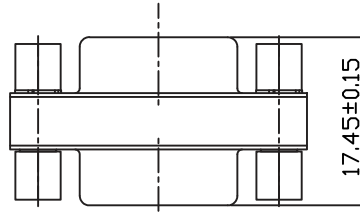
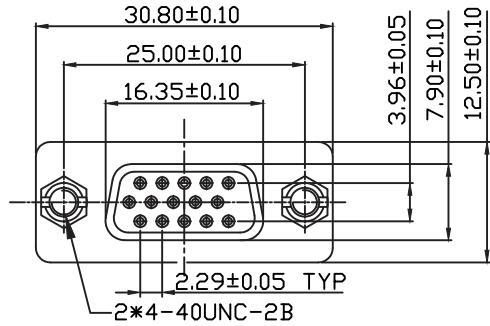

Screw Specification

Electrical Specification:

Current Rating: 2 AMP

Insulator Resistance: 5000M ohms Min. at DC 500V

Contact Resistance: 20m ohms Max. at DC 100mA

Operating Temperature: -55°C~+105°C

Material:

Housing: 30% Glass Filled PBT UL94V-0

Contacts: Phosphor Bronze

Shell: Steel, 100u" Tin Over 50u" Min Nickel

Clinch Nut: Brass, 100u" Min Nickel Plated

Screwlock: Brass, 100u" Min Nickel Plated

ORDER INFORMATION

Product NO: ERYAYA86-XXF/XXF-L

Contact Number of Row

A86=3 Row Type

Number of Contacts

15M/15M

15F/15F

15M/15F

L=Blue B=Black

NINGBO ERYCO ELECTRONIC CO.,LTD

UNITS:mm	SHEET SIZE: A4		SCALE:---	DRWN BY PAN
0~3	3~18	18~50	50~120	CHK'D BY FENG
±0.12	±0.15	±0.3	±0.5	APPR BY ZHAN

MINI ADAPTOR HDB 9-25Pin Female-Female

THIRD ANGLE PROJECTION

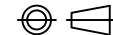

ERYAYA86-XXF/XXF-L

RoHS Compliant

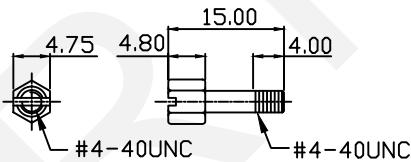
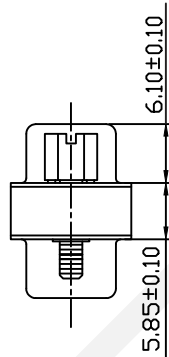
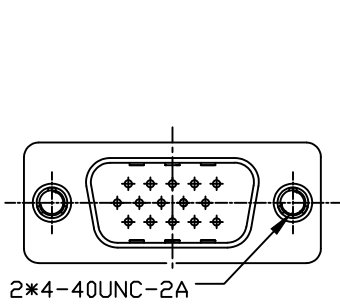
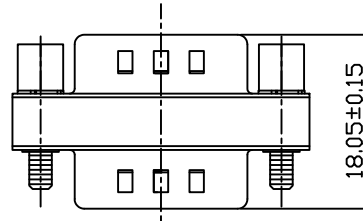
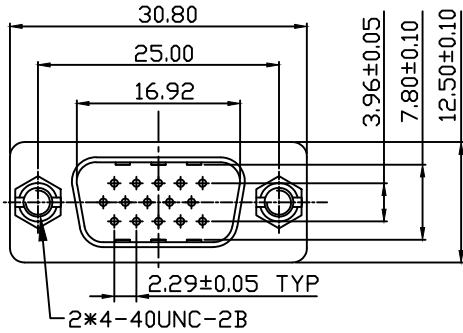

Screw Specification

Electrical Specification:

Current Rating: 2 AMP

Insulator Resistance: 5000M ohms Min. at DC 500V

Contact Resistance: 20m ohms Max. at DC 100mA

Operating Temperature: -55°C~+105°C

Material:

Housing: 30% Glass Filled PBT UL94V-0

Contacts: Phosphor Bronze

Shell: Steel, 100u" Tin Over 50u" Min Nickel

Clinch Nut: Brass, 100u" Min Nickel Plated

Screwlock: Brass, 100u" Min Nickel Plated

ORDER INFORMATION

Product NO.: ERYAYA86-XXM/XXM-L

Contact Number of Row

A86=3 Row Type

Number of Contacts

15M/15M

15F/15F

15M/15F

L=Blue B=Black

NINGBO ERYCO ELECTRONIC CO.,LTD

UNITS:mm	SHEET SIZE: A4			SCALE:---	DRWN BY PAN
0~3	3~18	18~50	50~120	CHK'D BY FENG	
±0.12	±0.15	±0.3	±0.5	APPR BY ZHAN	

MINI ADAPTOR HDB 9-25Pin Male-Male

THIRD ANGLE PROJECTION

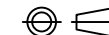

ERYAYA86-XXM/XXM-L

RoHS Compliant

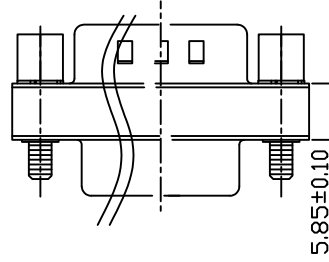
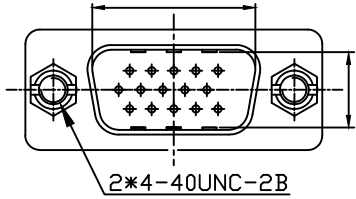

Electrical Specification:

Current Rating: 2 AMP

Insulator Resistance: 5000M ohms Min. at DC 500V

Contact Resistance: 20m ohms Max. at DC 100mA

Operating Temperature: -55°C~+105°C

Material:

Housing: 30% Glass Filled PBT UL94V-0

Contacts: Phosphor Bronze

Shell: Steel, 100u" Tin Over 50u" Min Nickel

Clinch Nut: Brass, 100u" Min Nickel Plated

Screwlock: Brass, 100u" Min Nickel Plated

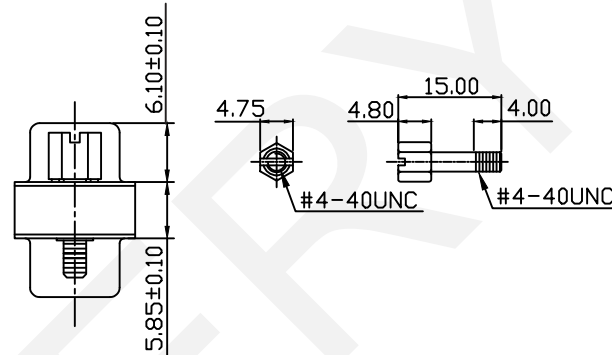
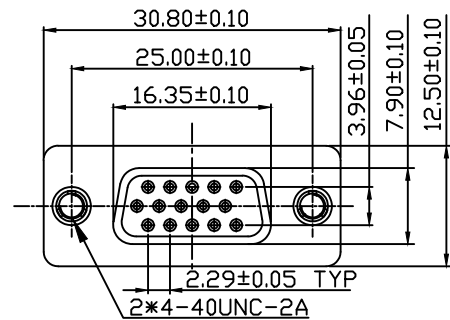

ORDER INFORMATION

Product NO: ERYAYA86-XXM/XXF-L

Contact Number of Row

A86=3 Row Type

Number of Contacts

15M/15M

15F/15F

15M/15F

L=Blue B=Black

NINGBO ERYCO ELECTRONIC CO.,LTD

UNITS:mm	SHEET SIZE: A4		SCALE:---	DRWN BY PAN
0~3	3~18	18~50	50~120	CHK'D BY FENG
±0.12	±0.15	±0.3	±0.5	APPR BY ZHAN

MINI ADAPTOR HDB 9-25Pin Male-Female

THIRD ANGLE PROJECTION

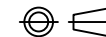

ERYAYA86-XXM/XXF-L