

RoHS Compliant

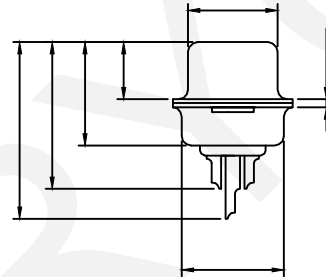
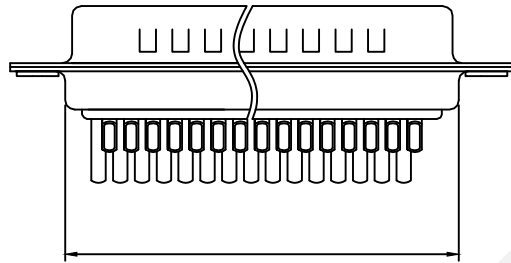
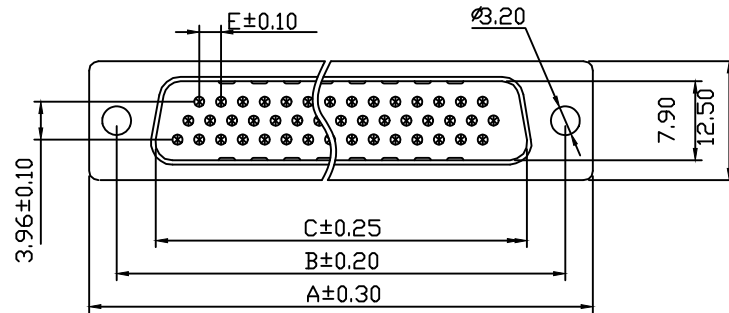

Material:

Housing: PBT+30% Glass Filled, UL94V-0

Contacts: Brass,

Gold Plating On Contact Area,

Tin On Solder Tail.

Shell: Steel,

Front Shell Nickel Plating,

Back Shell Tin Plating

Electrical Characteristics:

Current Rating: 5AMP

Insulator Resistance: 1000MΩ Min. at DC 500V

Withstanding Voltage: 500V AC (rms) For 1 Minute

Contact Resistance: 20MΩ Max. Initial

Operating Temperature: -55°C ~ +105°C

Order Information:

ERYAYB14-XX-M-L

D-SUB Connector,

3 Row Solder Type

XX-No. of 15, 26, 44, 62 Pins

Connector Type:

M-Male F-Female,

Housing Color:

L-Blue B-Black W-White

Number of Contacts	DIMENSION				
	A±0.30	B±0.20	C±0.25	D±0.25	E±0.10
15	30.80	25.00	16.90	19.30	2.29
26	39.20	33.30	25.25	27.60	2.29
44	53.10	47.04	38.96	41.10	2.29
62	69.34	63.50	55.40	57.30	2.41

UNITS:mm	SHEET SIZE: A4	SCALE:---	DRWN BY PAN
0~3	3~18	18~50	50~120
±0.12	±0.15	±0.3	±0.5

D-SUB Connector, Solder Type, Female	
THIRD ANGLE PROJECTION	ERYAYB14-XX-M-L

NINGBO ERYCO ELECTRONIC CO.,LTD

CHK'D BY FENG

APPR BY ZHAN

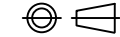

ERYAYB14-XX-M-L

RoHS Compliant

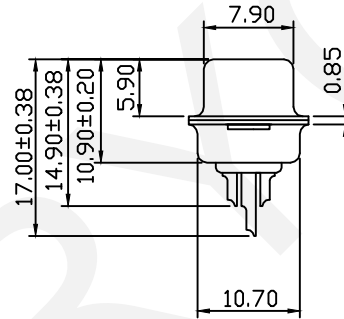
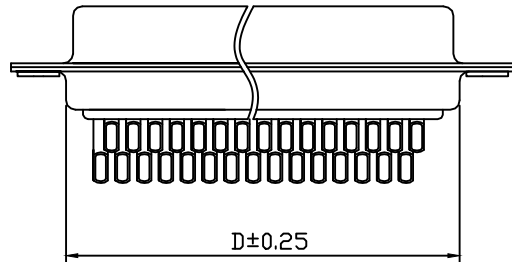
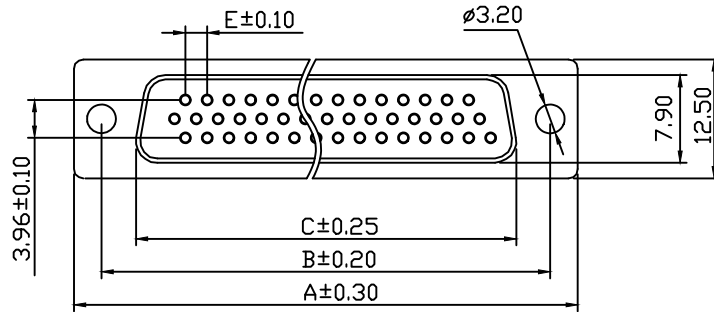

Material:

Housing:PBT+30% Glass Filled,UL94V-0

Contacts:Brass ,

Gold Plating On Contact Area,

Tin On Solder Tail.

Shell:Steel,

Front Shell Nickel Plating,

Back Shell Tin Plating

Electrical Characteristics:

Current Rating:5AMP

Insulator Resistance:1000MΩ Min. at DC 500V

Withstanding Voltage: 500V AC (rms) For 1 Minute

Contact Resistance:20MΩ Max. Initial

Operating Temperature:-55°C~+105°C

Order Information:

ERYAYB14-XX-F-L

D-SUB Connector,

3 Row Solder Type

XX-No.of 15,26,44,62 Pins

Connector Type:

M-Male F-Female,

Housing Color:

L-Blue B-Black W-White

Number of Contacts	DIMENSION				
	A±0.30	B±0.20	C±0.25	D±0.25	E±0.10
15	30.80	25.00	16.30	19.30	2.29
26	39.20	33.30	24.60	27.60	2.29
44	53.10	47.04	38.30	41.10	2.29
62	69.34	63.50	54.80	57.30	2.41

UNITS:mm	SHEET SIZE: A4	SCALE:---	DRWN BY PAN
0~3	3~18	18~50	50~120
±0.12	±0.15	±0.3	±0.5
NINGBO ERYCO ELECTRONIC CO.,LTD		CHK'D BY FENG	APPR BY ZHAN

D-SUB Connector,Solder Type,Female

THIRD ANGLE PROJECTION

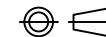

ERYAYB14-XX-F-L