

RoHS Compliance

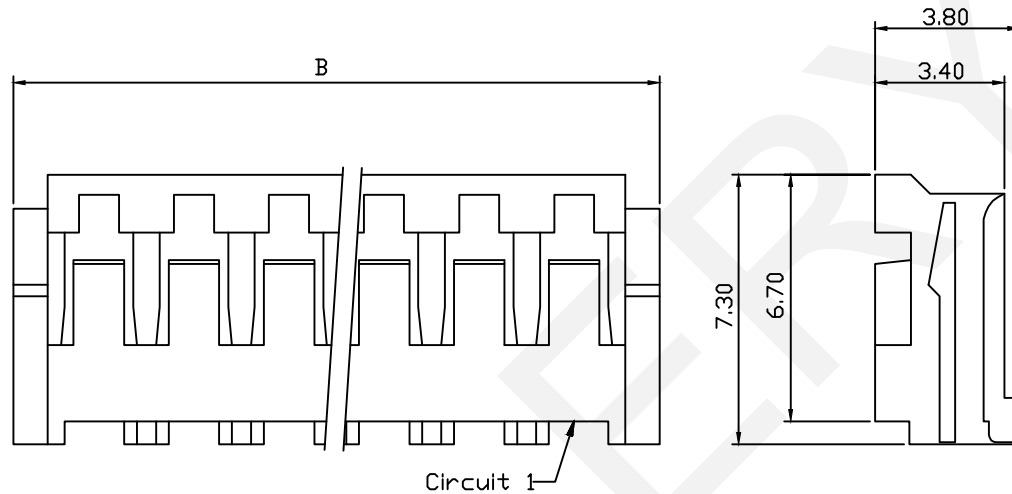
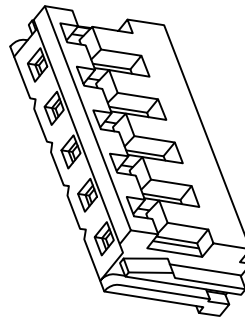
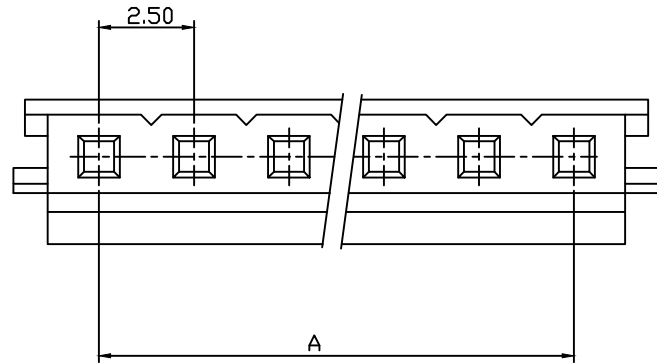

Pin	Dimension(mm)	
	A	B
02	2.50	7.00
03	5.00	9.50
04	7.50	12.00
05	10.00	14.50
06	12.50	17.00
07	15.00	19.50
08	17.50	22.00
09	20.00	24.50
10	22.50	27.00
11	25.00	29.50
12	27.50	32.00
13	30.00	34.50
14	32.50	37.00
15	35.00	39.50

Material:  
Housing: PA66,UL94V-0,White

Electrical Characteristics:  
Rated Current : 3.0AMP  
Voltage Rating : 250V AC,DC  
Temperature Range: -25°C~+85°C  
Insulator Resistance: 1000MΩ/Min.  
Withstanding Voltage: 800V AC/Minute  
Contact Resistance: 10MΩ/Max

Order Information:

ERYAYL5-2.50-XX-H

Pitch:2.50mm

XX-No.of 02~15Pin

Type:

T-Terminal H-Hosing

S-Straight Male Pin

R/R1-Right Angle Male Pin

NINGBO ERYCO ELECTRONIC CO.,LTD

UNITS:mm	SHEET SIZE: A4			SCALE:---	DRWN BY PAN
0~3	3~18	18~50	50~120	CHK'D BY FENG	
±0.12	±0.15	±0.3	±0.5	APPR BY ZHAN	

2.50mm Pitch EH Type  
Wire To Board Connector

THIRD ANGLE PROJECTION

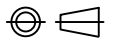

ERYAYL5-2.50-XX-H

RoHS Compliance

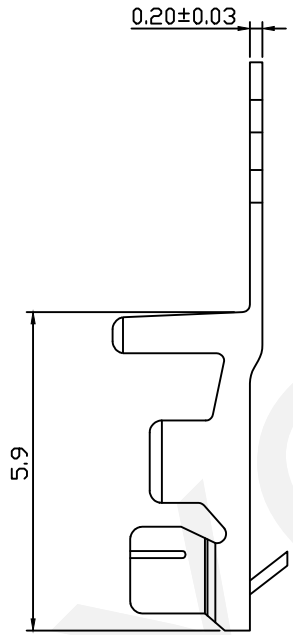
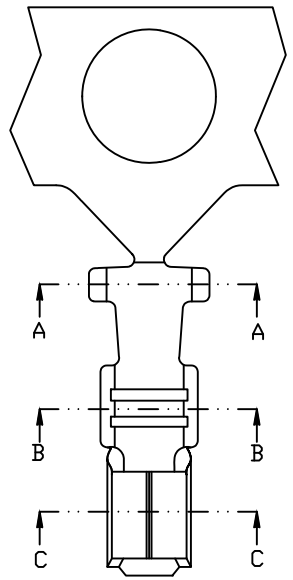

Material:  
 Terminal: Phosphor Bronze  
 Plating: Tin plated  
 Applicable Wires: AWG #22~#24  
 Insulation  $\phi$ .D: 1.9mm  
 Qty/Reel: 10000 PCS

Electrical Characteristics:  
 Current Rating : 3.0AMP  
 Voltage Rating : 250V AC,DC  
 Temperature Range: -25°C~+85°C  
 Insulator Resistance: 1000M $\Omega$ /Min.  
 Withstanding Voltage: 800V AC/Minute  
 Contact Resistance: 20M $\Omega$ /Max

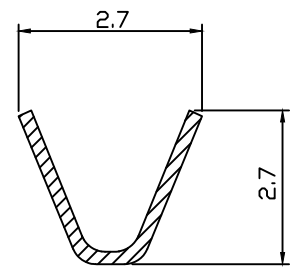

A-A

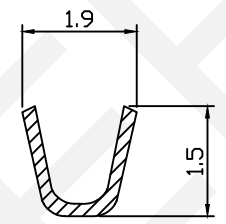

B-B

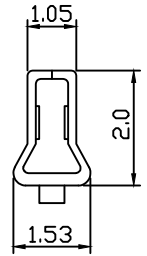

C-C

Order Information:  
 ERYAYL5-2.50-T

Pitch: 2.50mm  
 Type: \_\_\_\_\_  
 T-Terminal H-Hosing  
 S-Straight Male Pin  
 R/R1-Right Angle Male Pin

NINGBO ERYCO ELECTRONIC CO.,LTD

UNITS:mm	SHEET SIZE: A4			SCALE:---	DRWN BY PAN
0~3	3~18	18~50	50~120	CHK'D BY FENG	
±0.12	±0.15	±0.3	±0.5	APPR BY ZHAN	

2.50mm Pitch EH Type  
 Wire To Board Connector

THIRD ANGLE PROJECTION

ERYAYL5-2.50-T

RoHS Compliance

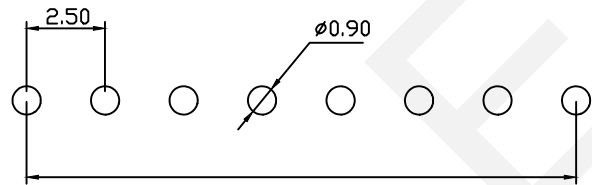
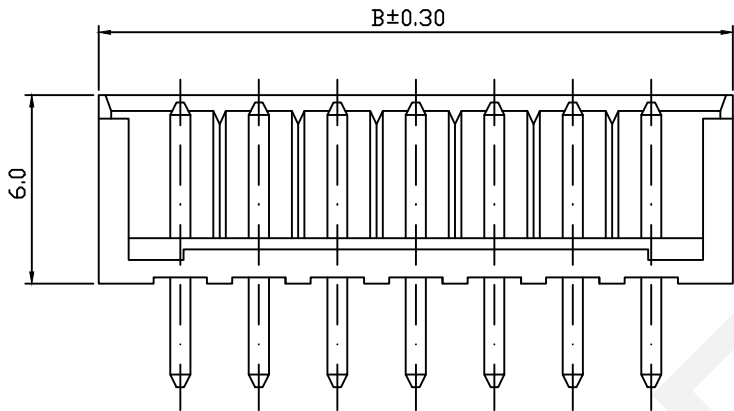
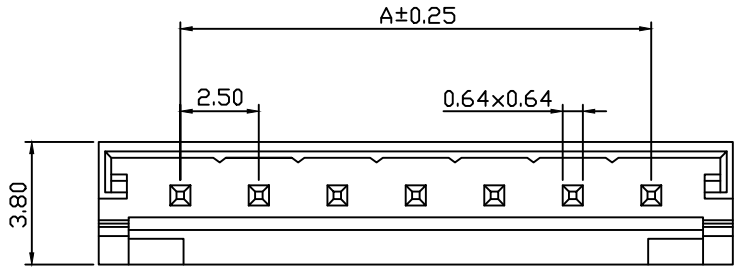

Recommended PCB Layout

Material:  
 Housing: PA66,UL94V-0,White  
 Contact:Brass  
 Plating: Tin plate

Electrical Characteristics:  
 Rated Current : 3.0AMP  
 Voltage Rating : 250V AC,DC  
 Temperature Range: -25°C~+85°C  
 Insulator Resistance: 1000MΩ/Min.  
 Withstanding Voltage: 800V AC/Minute  
 Contact Resistance: 20MΩ/Max

Pin	Dimension(mm)	
	A	B
02	2.50	7.50
03	5.00	10.00
04	7.50	12.50
05	10.00	15.00
06	12.50	17.50
07	15.00	20.00
08	17.50	22.50
09	20.00	25.00
10	22.50	27.50
11	25.00	30.00
12	27.50	32.50
13	30.00	35.00
14	32.50	37.50
15	35.00	40.00
16	37.50	42.50

Order Information:  
 ERYAYL5-2.50-XX-S

Pitch:2.50mm  
 XX-No.of 02~16Pin  
 Type: \_\_\_\_\_  
 T-Terminal H-Hosing  
 S-Straight Male Pin  
 R/R1-Right Angle Male Pin

NINGBO ERYCO ELECTRONIC CO.,LTD

UNITS:mm	SHEET SIZE: A4			SCALE:---	DRWN BY PAN
0~3	3~18	18~50	50~120	CHK'D BY FENG	
±0.12	±0.15	±0.3	±0.5	APPR BY ZHAN	

2.50mm Pitch EH Type Wire To Board Connector	
THIRD ANGLE PROJECTION 	ERYAYL5-2.50-XX-S

RoHS Compliance

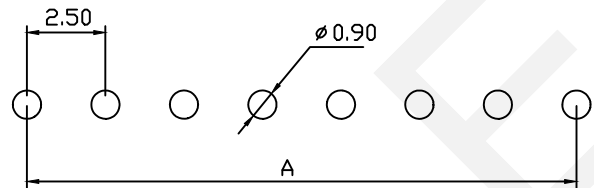
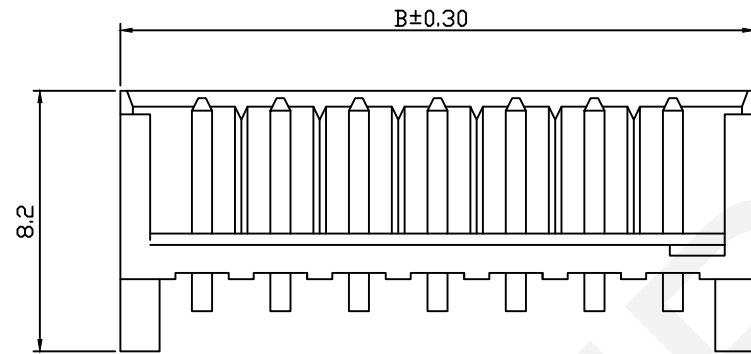
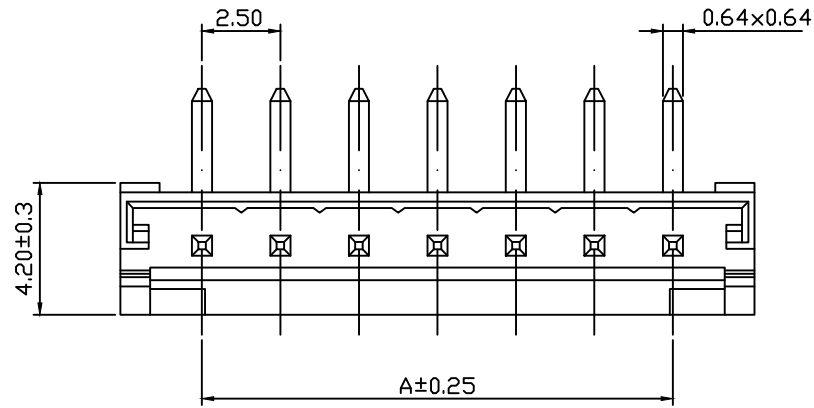

Recommended PCB Layout

Pin	Dimension(mm)	
	A	B
02	2.50	7.50
03	5.00	10.00
04	7.50	12.50
05	10.00	15.00
06	12.50	17.50
07	15.00	20.00
08	17.50	22.50
09	20.00	25.00
10	22.50	27.50
11	25.00	30.00
12	27.50	32.50
13	30.00	35.00
14	32.50	37.50
15	35.00	40.00

Material:

Housing: PA66,UL94V-0,White

Contact:Brass

Plating: Tin plate

Electrical Characteristics:

Rated Current : 3.0AMP

Voltage Rating : 250V AC,DC

Temperature Range: -25°C~+85°C

Insulator Resistance: 1000MΩ/Min.

Withstanding Voltage: 800V AC/Minute

Contact Resistance: 20MΩ/Max

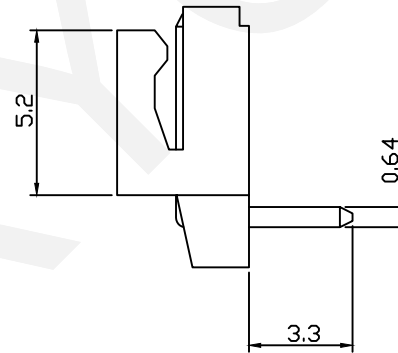

Order Information:

ERYAYL5-2.50-XX-R

Pitch:2.50mm

XX-No.of 02~15Pin

Type: \_\_\_\_\_

T-Terminal H-Hosing

S-Straight Male Pin

R/R1-Right Angle Male Pin

NINGBO ERYCO ELECTRONIC CO.,LTD

UNITS:mm	SHEET SIZE: A4			SCALE:---	DRWN BY PAN
0~3	3~18	18~50	50~120	CHK'D BY FENG	
±0.12	±0.15	±0.3	±0.5	APPR BY ZHAN	

2.50mm Pitch IL-G Type  
Wire To Board Connector

THIRD ANGLE PROJECTION

ERYAYL5-2.50-XX-R

RoHS Compliance

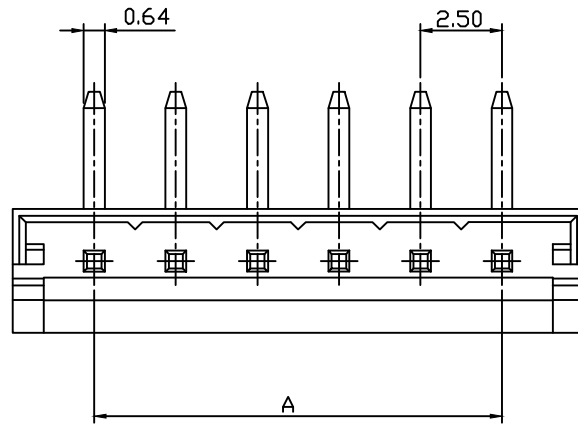

Pin	Dimension(mm)	
	A	B
02	2.50	7.50
03	5.00	10.00
04	7.50	12.50
05	10.00	15.00
06	12.50	17.50
07	15.00	20.00
08	17.50	22.50
09	20.00	25.00
10	22.50	27.50
11	25.00	30.00
12	27.50	32.50
13	30.00	35.00
14	32.50	37.50
15	35.00	40.00

Material:  
 Housing: PA66,UL94V-0,White  
 Contact:Brass  
 Plating: Tin plate

Electrical Characteristics:  
 Rated Current : 3.0AMP  
 Voltage Rating : 250V AC,DC  
 Temperature Range: -25°C~+85°C  
 Insulator Resistance: 1000MΩ/Min.  
 Withstanding Voltage: 800V AC/Minute  
 Contact Resistance: 20MΩ/Max

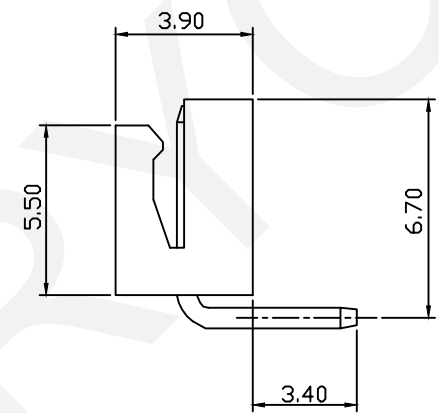
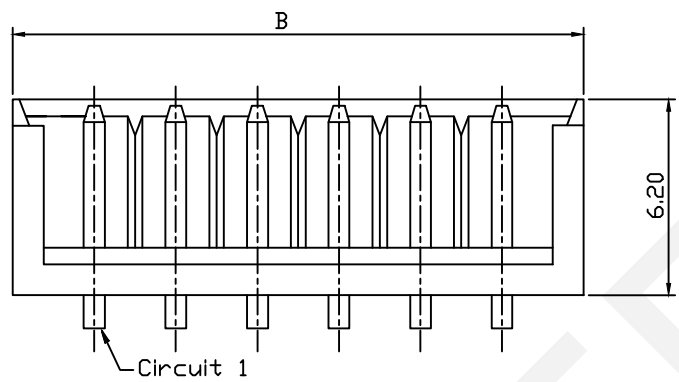

Order Information:  
 ERYAYL5-2.50-XX-R1

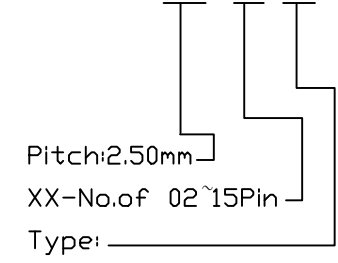

Type: \_\_\_\_\_  
 T-Terminal H-Hosing  
 S-Straight Male Pin  
 R/R1-Right Angle Male Pin

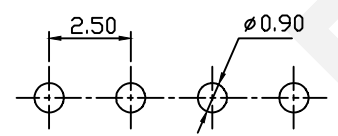

PCB Layout

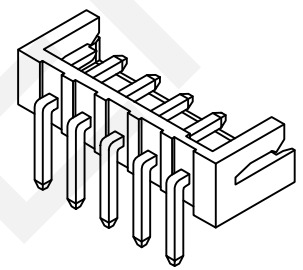

NINGBO ERYCO ELECTRONIC CO.,LTD

UNITS:mm	SHEET SIZE: A4	SCALE:---	DRWN BY PAN
0~3	3~18	18~50	50~120
±0.12	±0.15	±0.3	±0.5

CHK'D BY FENG  
 APPR BY ZHAN

2.50mm Pitch IL-G Type  
 Wire To Board Connector

THIRD ANGLE PROJECTION

ERYAYL5-2.50-XX-R1