

PCB LAYOUT

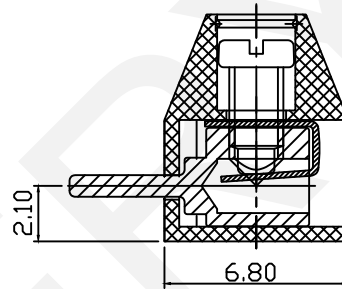
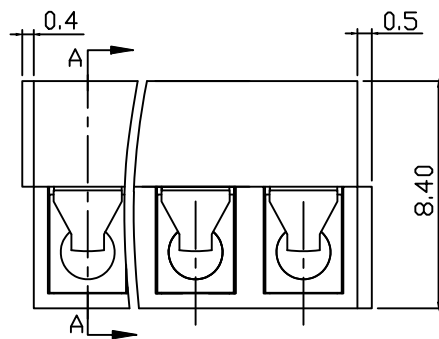

SECTION A-A

Material

Screw:M2.5, Steel,Zn plated  
 Shrapnel:Phosor bronze ,Nickel plated  
 Pin header:Brass , Tin plated  
 Housing:PA66. UL94V-0

Electrical

Rated voltage:125V  
 Rated current: 10A  
 Wire range:24~18AWG 1.0mm  
 Contact Resistance: 20 mΩ  
 Insulation resistance: 500MΩ/DC500V  
 Withstand voltage: AC2000V/1min

Mechanical

Temp.Range:-40℃~+105℃  
 Soldering:250℃±5℃ for 5S  
 Torque:0.2 N.m (1.77Lb. in)  
 Strip length: 4.5~5mm

Order Information

ERYBY50R-3.50-XXP-4 S XX

Terminal Block

Pitch

No. of Pole

Product Cde:00~99

Screw:S-Slot Screw

C-Cross Screw

Color:4-Green

NINGBO ERYCO ELECTRONIC CO.,LTD

UNITS:mm	SHEET SIZE: A4			SCALE:---	DRWN BY PAN
0~3	3~18	18~50	50~120	CHK'D BY FENG	
±0.12	±0.15	±0.3	±0.5	APPR BY ZHAN	

Screw Conn Term Block 3.50mm

THIRD ANGLE PROJECTION

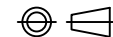

ERYBY50R-3.50-XXP-4S

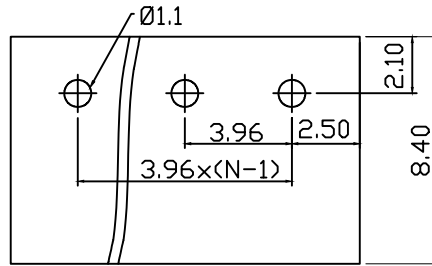
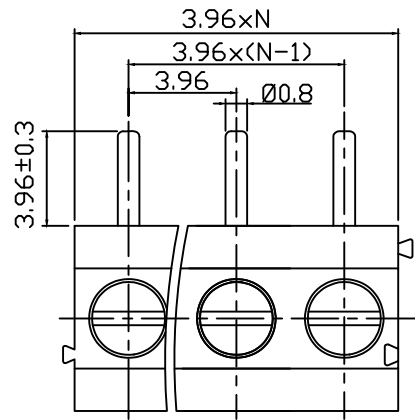

PCB LAYOUT

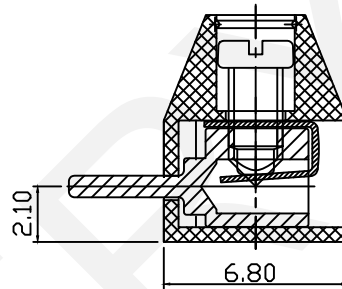
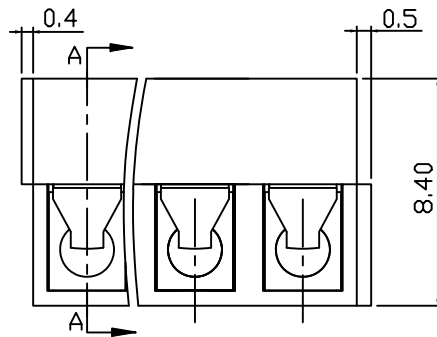

SECTION A-A

Material

Screw:M2.5, Steel,Zn plated  
 Shrapnel:Phosor bronze ,Nickel plated  
 Pin header: Brass , Tin plated  
 Housing:PA66. UL94V-0

Electrical

Rated voltage:125V  
 Rated current: 10A  
 Wire range:24~18AWG 1.0mm<sup>2</sup>  
 Contact Resistance: 20 mΩ  
 Insulation resistance: 500MΩ/DC500V  
 Withstand voltage: AC2000V/1min

Mechanical

Temp.Range:-40℃~+105℃  
 Soldering:250℃±5℃ for 5S  
 Torque:0.2 N.m (1.77Lb. in)  
 Strip length: 4.5~5mm

Order Information

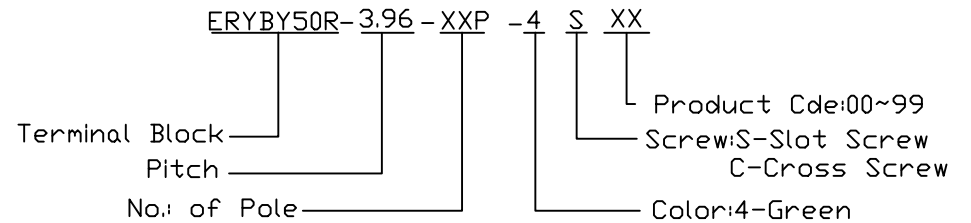

NINGBO ERYCO ELECTRONIC CO.,LTD

UNITS:mm	SHEET SIZE: A4			SCALE:---	DRWN BY PAN
0~3	3~18	18~50	50~120	CHK'D BY FENG	
±0.12	±0.15	±0.3	±0.5	APPR BY ZHAN	

Screw Conn Term Block 3.96mm

THIRD ANGLE PROJECTION



ERYBY50R-3.96-XXP-4S